

Digital Mockup 과 Functional Mockup의 결합을 통한 Digital Product Experience 구현



3DEXPERIENCE

IF WE  ask the right questions...
we can change the game.

History of Dassault Systemes & CATIA

From
1981-2012

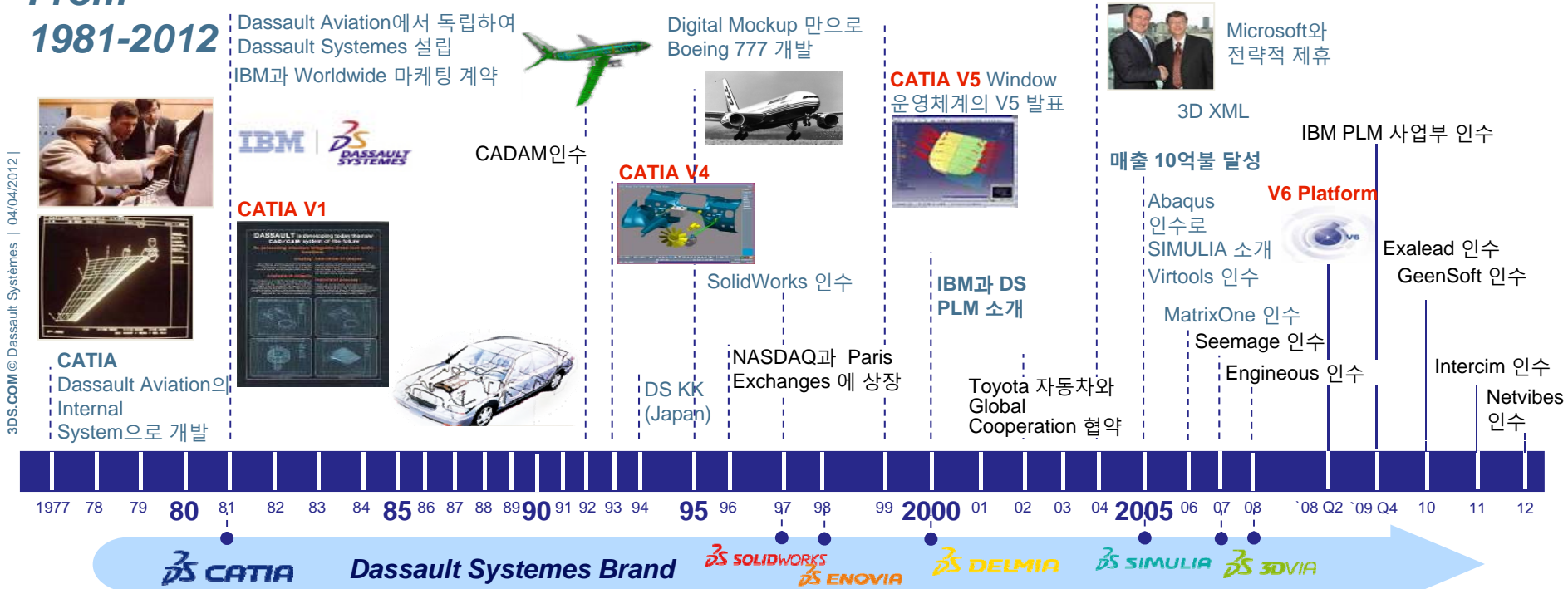

Global Position of Dassault Systemes

3DS.COM © Dassault Systemes | 04/04/2012 |

- 3DS CATIA
- 3DS SOLIDWORKS
- 3DS SIMULIA
- 3DS DELMIA
- 3DS ENOVIA
- 3DS 3DVIA
- 3DS 3DSW™
- 3DS EXALEAD



#	Company	Software Revenues mln US\$	Software Revenue growth	Total Revenues mln US\$	Software Revenue share
1	Microsoft>	54,270	10.6%	67,383	80.5%
2	IBM>	22,485	5.1%	99,870	22.5%
3	Oracle>	20,958	12.8%	30,180	69.4%
4	SAP>	12,558	10.5%	16,654	75.4%
5	Ericsson>	7,274	-4.2%	30,307	24.0%
6	HP>	6,669	7.9%	126,562	5.3%
7	Symantec>	5,636	1.3%	6,013	93.7%
8	Nintendo>	5,456	-19.8%	13,766	39.6%
9	Activision Blizzard>	4,447	3.9%	4,447	100.0%
10	EMC>	4,356	10.0%	17,015	25.6%
11	Nokia Siemens Networks>	4,229	-6.6%	16,918	25.0%
12	CA>	4,136	3.1%	4,454	92.9%
13	Electronic Arts>	3,413	-8.4%	3,413	100.0%
14	Adobe>	3,177	13.6%	3,826	83.0%
15	Alcatel-Lucent>	2,561	-4.6%	21,374	12.0%
16	Cisco>	2,383	11.5%	41,045	5.8%
17	Sony>	2,083	8.8%	83,039	2.5%
18	Hitachi>	1,939	22.0%	113,500	1.7%
19	Dassault>	1,885	19.0%	2,090	90.2%
20	BMC>	1,843	4.5%	1,981	93.0%
21	SunGard>	1,762	-11.7%	4,992	35.3%
22	Autodesk>	1,701	9.2%	1,932	88.0%
23	Konami>	1,643	3.1%	3,122	52.6%
24	Salesforce.com>	1,523	27.9%	1,628	93.6%
25	Sage>	1,485	-4.6%	2,228	66.7%

SOFTWARE TOP 100
THE WORLD'S LARGEST SOFTWARE COMPANIES

OUR LEGACY: opening the era of 'EXPERIENCE'

3D - Design

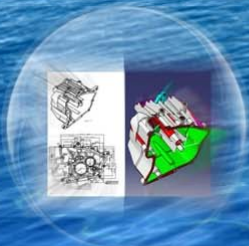

V3 | 1986

3D-DMU
Digital Mock-Up



V4 | 1994

3D-PLM
Product Lifecycle Management



V5 | 1999

3DEXPERIENCE



V6 | 2009

3D EXPERIENCE PLATFORM

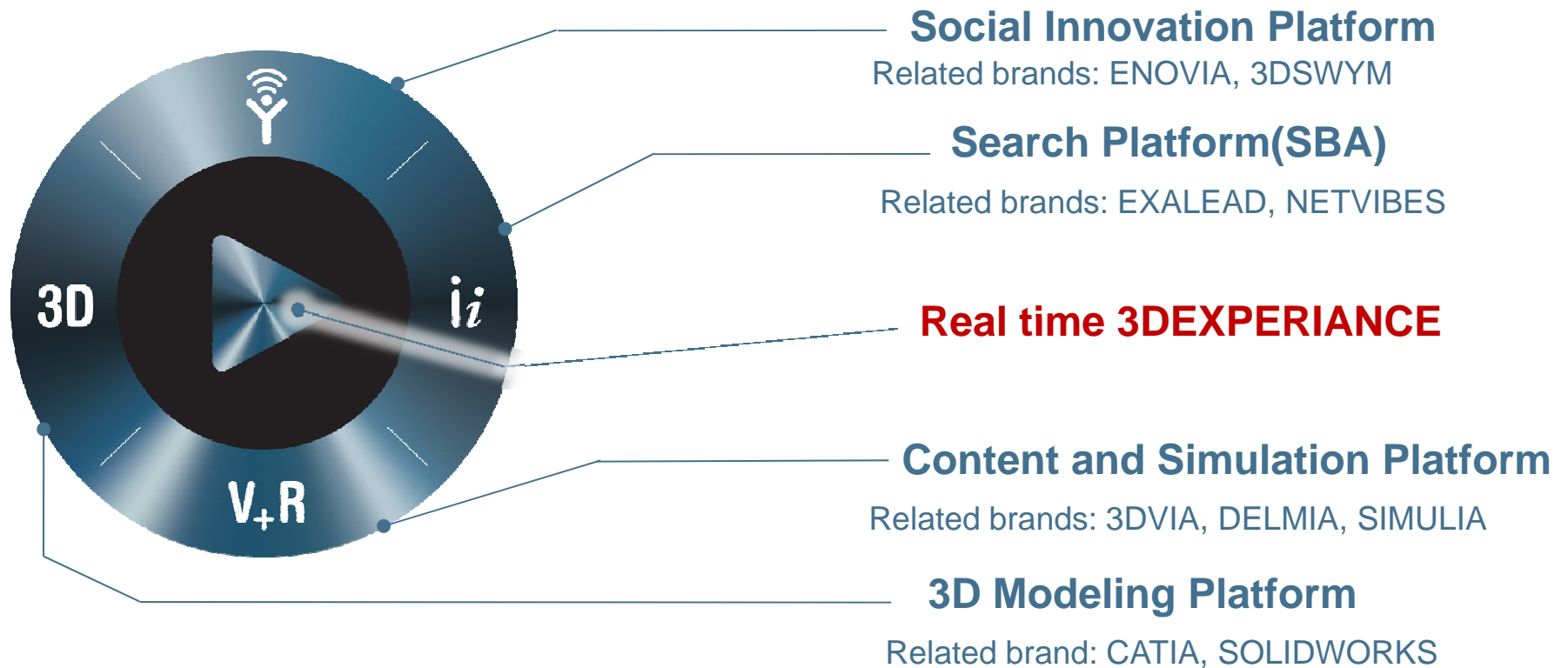

Paradigm Shift for Product Development

Digital Product Experience

From Digital Mockup

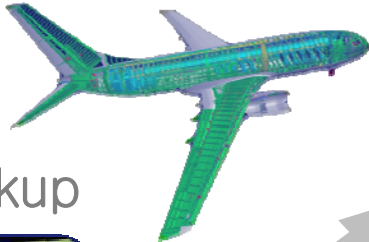

Digital Product Experience Domains

Live Architecture

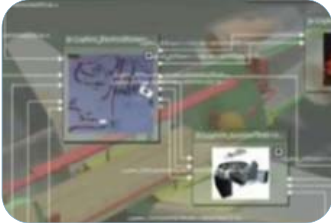

Live Design



Live Experience

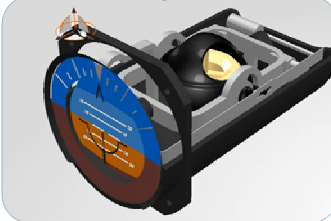

Live Engineering

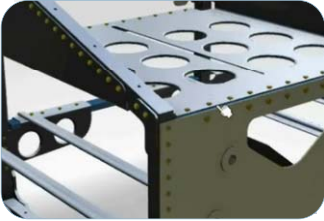

Live Function

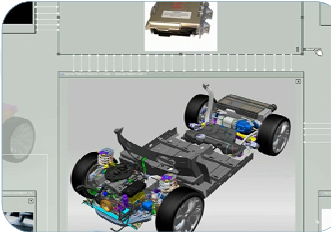

Live Design | Industrial Design

Creative Designer

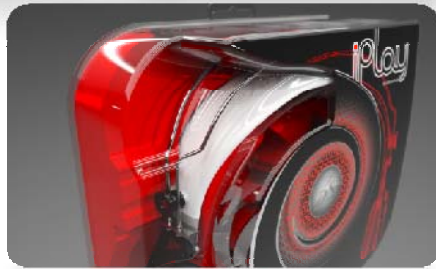

- Unified Industrial Design workflow solution
- Streamline Styling & Engineering collaboration
- Design Validation

Live Design | Industrial Design Natural Sketch

Creative Designer

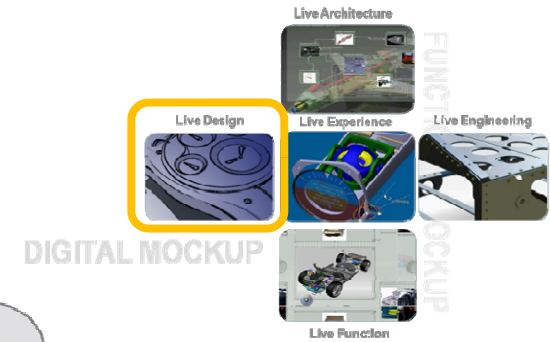
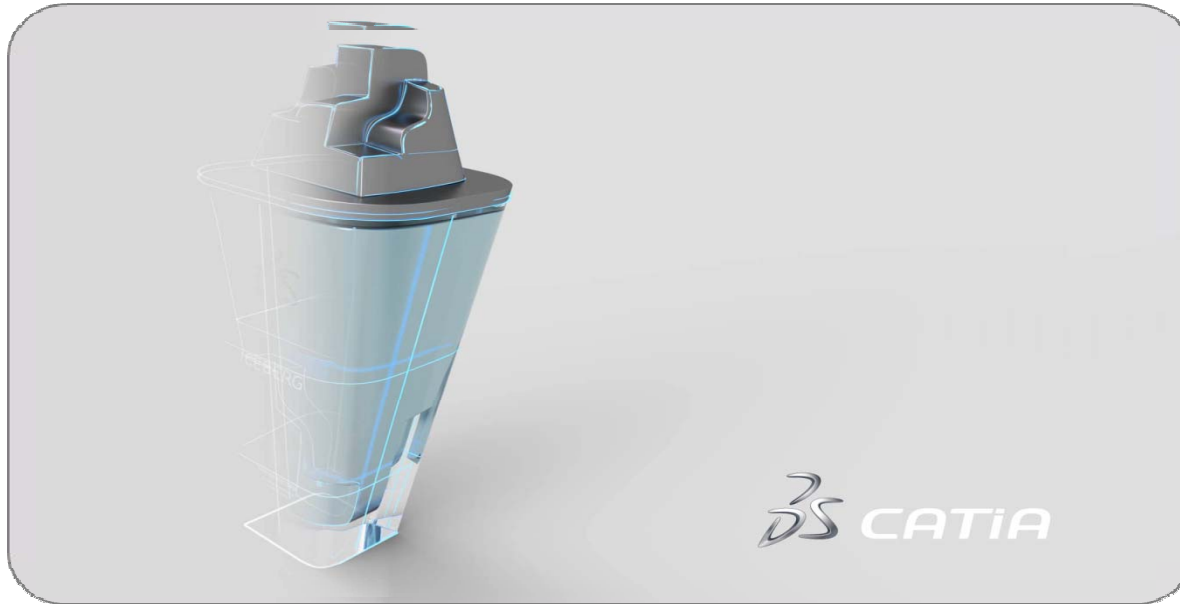

- Captures the natural gestures of the creative designer
- New paradigm to express and communicate the design intent

Live Design | Industrial Design, Surface Refinement

Live Rendering

Visualization & VR

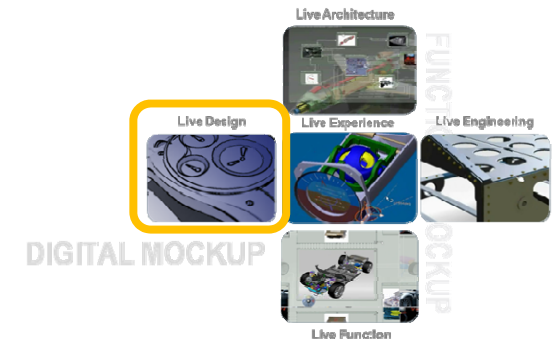

- Photorealistic imagery for everyone
- Simple & Integrated
- CATIA Icem Surface refinement know how integrated in V6
- Capture & Reuse paradigm



PSA PEUGEOT CITROËN

Bausch & Lomb Live Design



HONDA



BVLGARI

Live Architecture



Live Experience



Live Engineering

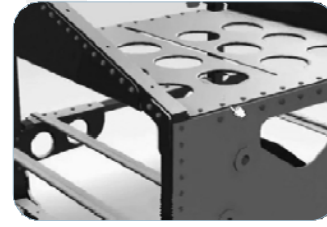

Live Function

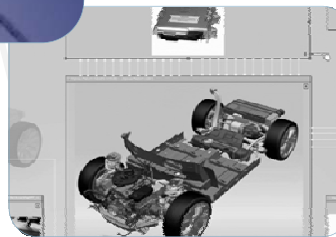

Digital Product Experience Domains

FUNCTIONAL MOCKUP

DIGITAL

Live Function | Model Based Engineering

Embedded Systems
Engineers

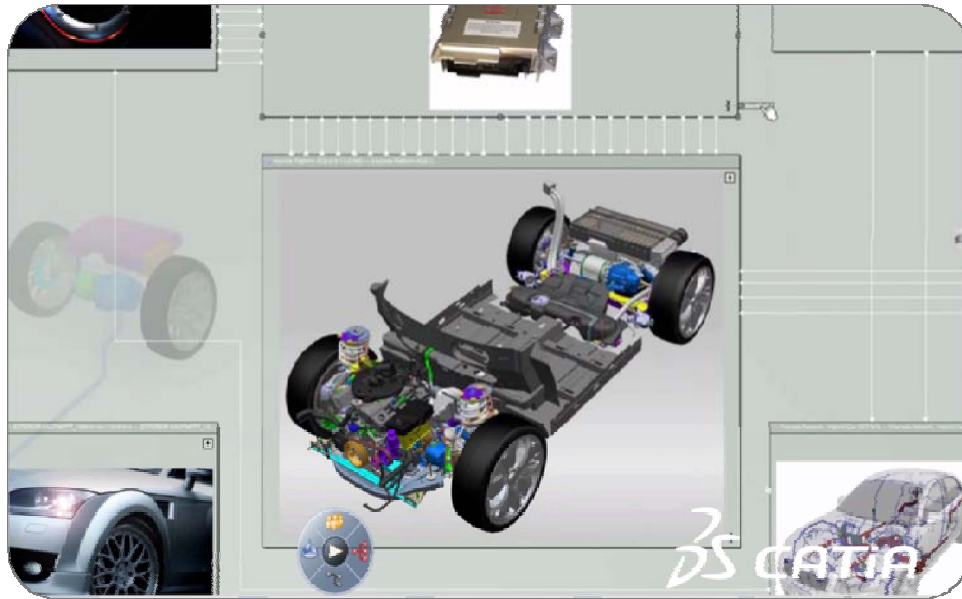

- Prototype lifelike Mechatronics Systems



Live Architecture

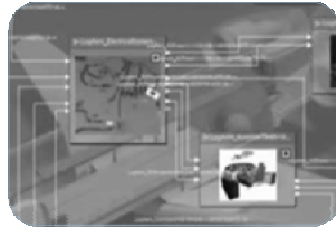

Live Design



Live Experience



Live Engineering

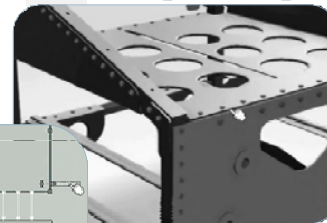

Digital Product Experience Domains

FUNCTION

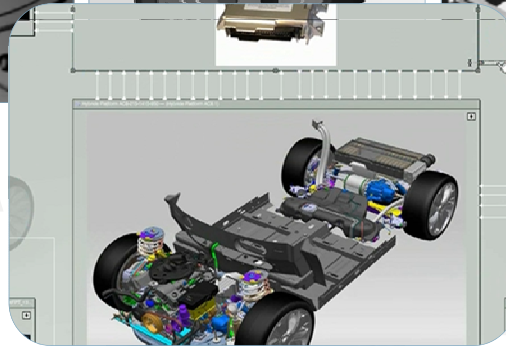

Live Function



Live Architecture Requirement Based Engineering

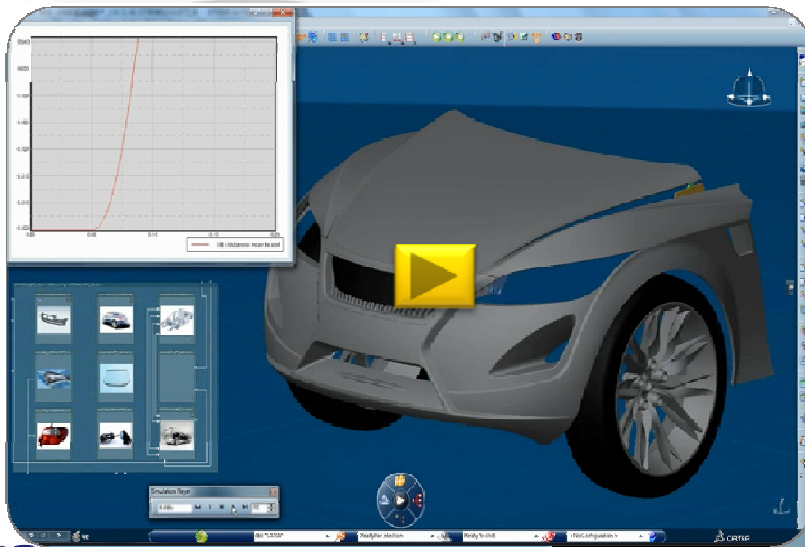

- Manage & trace Requirement, Architecture Design
- Rapid Requirements Management of large and complex products for designers

Live Engineering

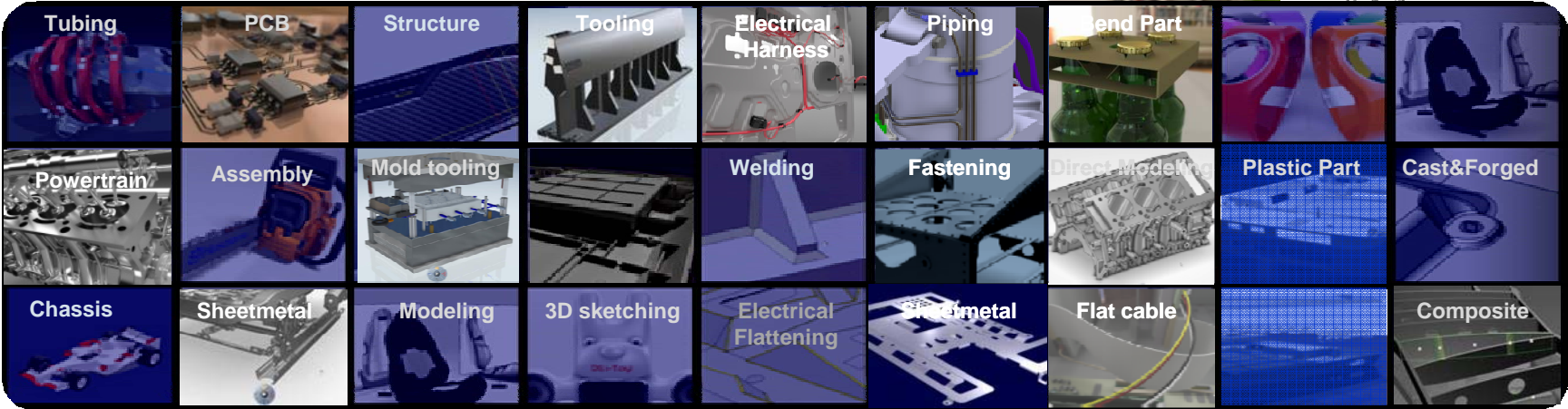

World-class process oriented for better productivity

Digital Product Experience Domains

Live Architecture

Live Design

Live Experience

Live Function

Live Engineering

Digital Product Experience

Live Architecture

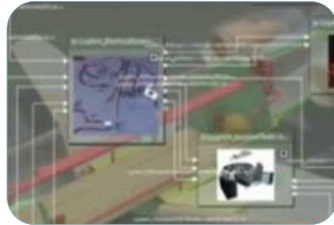

Live Design



Live Experience

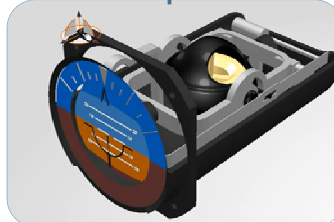

Live Engineering



DIGITAL MOCKUP

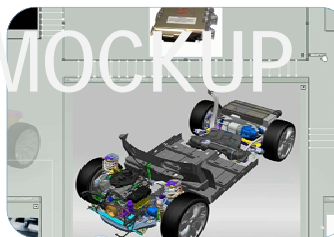

Live Function

FUNCTIONAL MOCKUP

